

DESCRIPTION

Compo 900

Pure architectural light fittings for all applications Compo series is a very classic cylindrical design in various sizes and mounting options that integrates elegantly into any architecture.

Uniformly illuminated product thanks to its 2 diffusers design. Opal diffuser provides homogeneous general lighting and Micro-prismatic diffuser is ideal for office lighting.

Available in direct only or direct – indirect light distribution options which perfect for office use, education, healthcare, retail, hospitality, and hotel.

npk design, the Netherlands



QUICKINFO

GENERAL

Material	Aluminium, Opal cover
Finish	Black
IP	IP20
Lifetime	L80/50,000h
Warranty	5 years

LED

LED Chip	Seoul
Lumen	9000lm/7000lm/55000lm
Efficacy	100lm/W
CRI	>90
CCT	3000K/4000K Switch as standard, 6500K on request
SDCM	>3
UGR	<19 (X=4H, Y=8H)

ELECTRICAL

Voltage	220-240V
Power	90/70/55W Switch
Driver(Build-in)	Phase Cut / DALI
Light distribution	Direct only

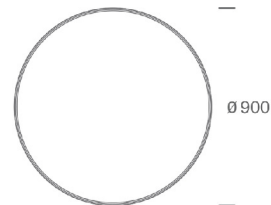
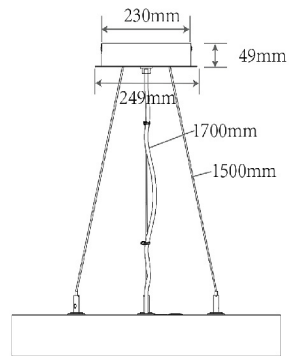

PURATI PTY LTD

Unit 10, 80 O'Riordan St, Alexandria NSW 2015  
 Tel: +61 2 8065 8181  
 sales@purati.com

**DESCRIPTION**

**Compo 900**

Pure architectural light fittings for all applications  
 Compo series is a very classic cylindrical design in various sizes and mounting options that integrates elegantly into any architecture.  
 Uniformly illuminated product thanks to its 2 diffusers design. Opal diffuser provides homogeneous general lighting and Micro-prismatic diffuser is ideal for office lighting.  
 Available in direct only or direct – indirect light distribution options which perfect for office use, education, healthcare, retail, hospitality, and hotel.  
 npk design, the Netherlands



**QUICKINFO**

**GENERAL**

Material	Aluminium, Opal cover
Finish	White
IP	IP20
Lifetime	L80/50,000h
Warranty	5 years

**LED**

LED Chip	Seoul
Lumen	9000lm/7000lm/55000lm
Efficacy	100lm/W
CRI	>90
CCT	3000K/4000K Switch as standard, 6500K on request
SDCM	>3
UGR	<19 (X=4H, Y=8H)

**ELECTRICAL**

Voltage	220-240V
Power	90/70/55W Switch
Driver(Build-in)	Phase Cut / DALI
Light distribution	Direct only

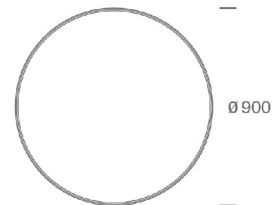
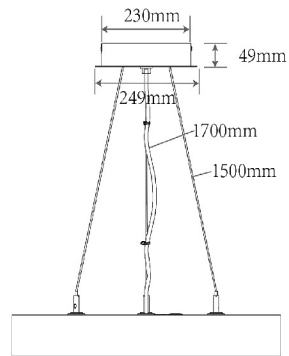

**PURATI PTY LTD**

Unit 10, 80 O'Riordan St, Alexandria NSW 2015  
 Tel: +61 2 8065 8181  
 sales@purati.com

**DESCRIPTION**

**Compo 900**

Pure architectural light fittings for all applications  
 Compo series is a very classic cylindrical design in various sizes and mounting options that integrates elegantly into any architecture.  
 Uniformly illuminated product thanks to its 2 diffusers design. Opal diffuser provides homogeneous general lighting and Micro-prismatic diffuser is ideal for office lighting.  
 Available in direct only or direct – indirect light distribution options which perfect for office use, education, healthcare, retail, hospitality, and hotel.  
 npk design, the Netherlands



**QUICKINFO**

**GENERAL**

Material	Aluminium, Opal cover
Finish	Brushed Silver
IP	IP20
Lifetime	L80/50,000h
Warranty	5 years

**LED**

LED Chip	Seoul
Lumen	9000lm/7000lm/55000lm
Efficacy	100lm/W
CRI	>90
CCT	3000K/4000K Switch as standard, 6500K on request
SDCM	>3
UGR	<19 (X=4H, Y=8H)

**ELECTRICAL**

Voltage	220-240V
Power	90/70/55W Switch
Driver(Build-in)	Phase Cut / DALI
Light distribution	Direct only

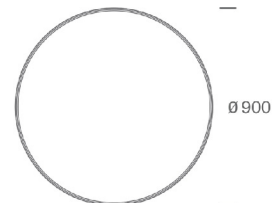
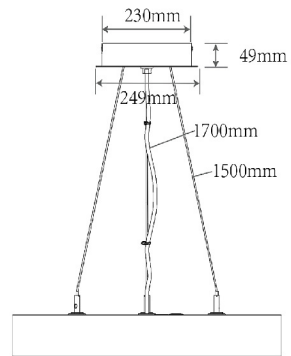

**DESCRIPTION**

**Compo 900**

Pure architectural light fittings for all applications  
 Compo series is a very classic cylindrical design in various sizes and mounting options that integrates elegantly into any architecture.  
 Uniformly illuminated product thanks to its 2 diffusers design. Opal diffuser provides homogeneous general lighting and Micro-prismatic diffuser is ideal for office lighting.  
 Available in direct only or direct – indirect light distribution options which perfect for office use, education, healthcare, retail, hospitality, and hotel.  
 npk design, the Netherlands



**QUICKINFO**

**GENERAL**

Material	Aluminium, Opal cover
Finish	Brushed Gold
IP	IP20
Lifetime	L80/50,000h
Warranty	5 years

**LED**

LED Chip	Seoul
Lumen	9000lm/7000lm/55000lm
Efficacy	100lm/W
CRI	>90
CCT	3000K/4000K Switch as standard, 6500K on request
SDCM	>3
UGR	<19 (X=4H, Y=8H)

**ELECTRICAL**

Voltage	220-240V
Power	90/70/55W Switch
Driver(Build-in)	Phase Cut / DALI
Light distribution	Direct only

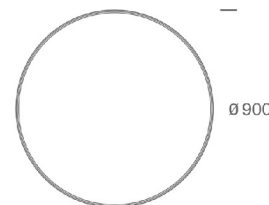
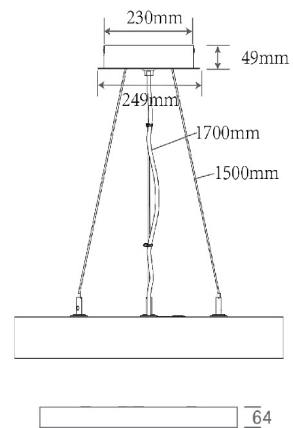

**PURATI PTY LTD**

Unit 10, 80 O'Riordan St, Alexandria NSW 2015  
 Tel: +61 2 8065 8181  
 sales@purati.com



**DESCRIPTION**

**Compo 900**

Pure architectural light fittings for all applications  
Compo series is a very classic cylindrical design in various sizes and mounting options that integrates elegantly into any architecture.

Uniformly illuminated product thanks to its 2 diffusers design. Opal diffuser provides homogeneous general lighting and Micro-prismatic diffuser is ideal for office lighting.

Available in direct only or direct – indirect light distribution options which perfect for office use, education, healthcare, retail, hospitality, and hotel.

npk design, the Netherlands



**QUICKINFO**

**GENERAL**

Material	Aluminium, Micro-prismatic cover
Finish	Black
IP	IP20
Lifetime	L80/50,000h
Warranty	5 years

**LED**

LED Chip	Seoul
Lumen	9000lm/7000lm/55000lm
Efficacy	100lm/W
CRI	>90
CCT	3000K/4000K Switch as standard, 6500K on request
SDCM	>3
UGR	<19 (X=4H, Y=8H)

**ELECTRICAL**

Voltage	220-240V
Power	90/70/55W Switch
Driver(Build-in)	Phase Cut / DALI
Light distribution	Direct only

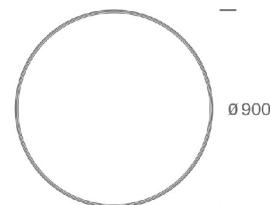
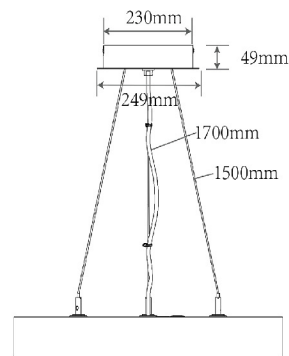

**PURATI PTY LTD**

Unit 10, 80 O'Riordan St, Alexandria NSW 2015  
Tel: +61 2 8065 8181  
sales@purati.com

**DESCRIPTION**

**Compo 900**

Pure architectural light fittings for all applications  
Compo series is a very classic cylindrical design in various sizes and mounting options that integrates elegantly into any architecture.

Uniformly illuminated product thanks to its 2 diffusers design. Opal diffuser provides homogeneous general lighting and Micro-prismatic diffuser is ideal for office lighting.

Available in direct only or direct – indirect light distribution options which perfect for office use, education, healthcare, retail, hospitality, and hotel.

npk design, the Netherlands



**QUICKINFO**

**GENERAL**

Material	Aluminium, Micro-prismatic cover
Finish	White
IP	IP20
Lifetime	L80/50,000h
Warranty	5 years

**LED**

LED Chip	Seoul
Lumen	9000lm/7000lm/55000lm
Efficacy	100lm/W
CRI	>90
CCT	3000K/4000K Switch as standard, 6500K on request
SDCM	>3
UGR	<19 (X=4H, Y=8H)

**ELECTRICAL**

Voltage	220-240V
Power	90/70/55W Switch
Driver(Build-in)	Phase Cut / DALI
Light distribution	Direct only

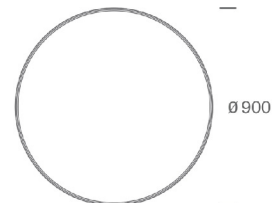
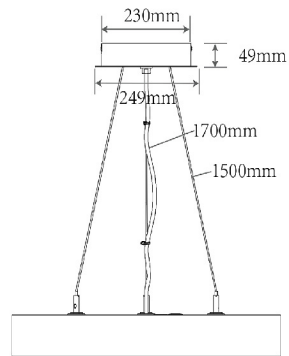

**PURATI PTY LTD**

Unit 10, 80 O'Riordan St, Alexandria NSW 2015  
Tel: +61 2 8065 8181  
sales@purati.com

**DESCRIPTION**

**Compo 900**

Pure architectural light fittings for all applications  
Compo series is a very classic cylindrical design in various sizes and mounting options that integrates elegantly into any architecture.  
Uniformly illuminated product thanks to its 2 diffusers design. Opal diffuser provides homogeneous general lighting and Micro-prismatic diffuser is ideal for office lighting.  
Available in direct only or direct – indirect light distribution options which perfect for office use, education, healthcare, retail, hospitality, and hotel.  
npk design, the Netherlands



**QUICKINFO**

**GENERAL**

Material	Aluminium, Micro-prismatic cover
Finish	Brushed Silver
IP	IP20
Lifetime	L80/50,000h
Warranty	5 years

**LED**

LED Chip	Seoul
Lumen	9000lm/7000lm/55000lm
Efficary	100lm/W
CRI	>90
CCT	3000K/4000K Switch as standard, 6500K on request
SDCM	>3
UGR	<19 (X=4H, Y=8H)

**ELECTRICAL**

Voltage	220-240V
Power	90/70/55W Switch
Driver(Build-in)	Phase Cut / DALI
Light distribution	Direct only

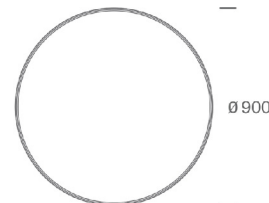
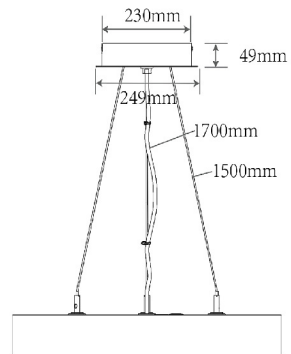

**DESCRIPTION**

**Compo 900**

Pure architectural light fittings for all applications  
Compo series is a very classic cylindrical design in various sizes and mounting options that integrates elegantly into any architecture.  
Uniformly illuminated product thanks to its 2 diffusers design. Opal diffuser provides homogeneous general lighting and Micro-prismatic diffuser is ideal for office lighting.  
Available in direct only or direct – indirect light distribution options which perfect for office use, education, healthcare, retail, hospitality, and hotel.  
npk design, the Netherlands



**QUICKINFO**

**GENERAL**

Material	Aluminium, Micro-prismatic cover
Finish	Brushed Gold
IP	IP20
Lifetime	L80/50,000h
Warranty	5 years

**LED**

LED Chip	Seoul
Lumen	9000lm/7000lm/55000lm
Efficacy	100lm/W
CRI	>90
CCT	3000K/4000K Switch as standard, 6500K on request
SDCM	>3
UGR	<19 (X=4H, Y=8H)

**ELECTRICAL**

Voltage	220-240V
Power	90/70/55W Switch
Driver(Build-in)	Phase Cut / DALI
Light distribution	Direct only

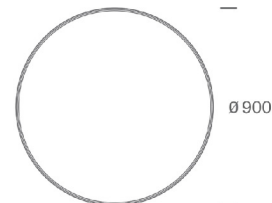
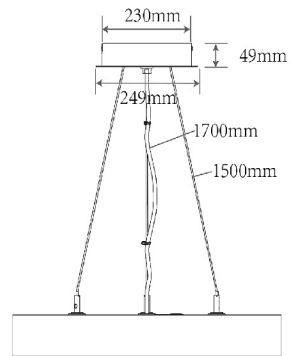

**PURATI PTY LTD**

Unit 10, 80 O'Riordan St, Alexandria NSW 2015  
Tel: +61 2 8065 8181  
sales@purati.com

**DESCRIPTION**

**Compo 900**

Pure architectural light fittings for all applications  
Compo series is a very classic cylindrical design in various sizes and mounting options that integrates elegantly into any architecture.

Uniformly illuminated product thanks to its 2 diffusers design. Opal diffuser provides homogeneous general lighting and Micro-prismatic diffuser is ideal for office lighting.

Available in direct only or direct – indirect light distribution options which perfect for office use, education, healthcare, retail, hospitality, and hotel.

npk design, the Netherlands



**QUICKINFO**

**GENERAL**

Material	Aluminium, Opal cover
Finish	Black
IP	IP20
Lifetime	L80/50,000h
Warranty	5 years

**LED**

LED Chip	Seoul
Lumen	9000lm/7000lm/55000lm
Efficacy	100lm/W
CRI	>90
CCT	3000K/4000K Switch as standard, 6500K on request
SDCM	>3
UGR	<19 (X=4H, Y=8H)

**ELECTRICAL**

Voltage	220-240V
Power	90/70/55W Switch
Driver(Build-in)	Phase Cut / DALI
Light distribution	Direct - Indirect

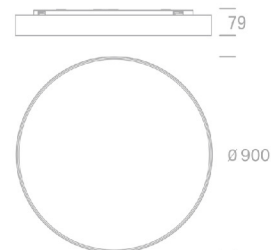
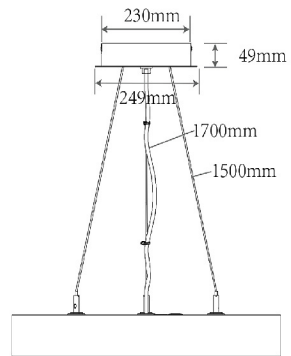

**PURATI PTY LTD**

Unit 10, 80 O'Riordan St, Alexandria NSW 2015  
Tel: +61 2 8065 8181  
sales@purati.com

**DESCRIPTION**

**Compo 900**

Pure architectural light fittings for all applications  
Compo series is a very classic cylindrical design in various sizes and mounting options that integrates elegantly into any architecture.

Uniformly illuminated product thanks to its 2 diffusers design. Opal diffuser provides homogeneous general lighting and Micro-prismatic diffuser is ideal for office lighting.

Available in direct only or direct – indirect light distribution options which perfect for office use, education, healthcare, retail, hospitality, and hotel.

npk design, the Netherlands



**QUICKINFO**

**GENERAL**

Material	Aluminium, Opal cover
Finish	White
IP	IP20
Lifetime	L80/50,000h
Warranty	5 years

**LED**

LED Chip	Seoul
Lumen	9000lm/7000lm/55000lm
Efficary	100lm/W
CRI	>90
CCT	3000K/4000K Switch as standard, 6500K on request
SDCM	>3
UGR	<19 (X=4H, Y=8H)

**ELECTRICAL**

Voltage	220-240V
Power	90/70/55W Switch
Driver(Build-in)	Phase Cut / DALI
Light distribution	Direct - Indirect

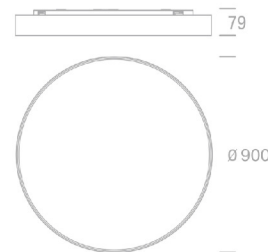
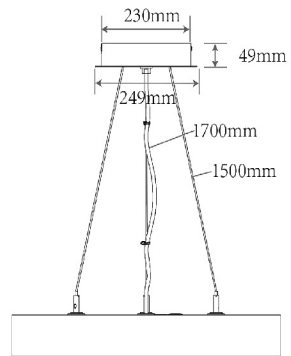

**PURATI PTY LTD**

Unit 10, 80 O'Riordan St, Alexandria NSW 2015  
Tel: +61 2 8065 8181  
sales@purati.com

**DESCRIPTION**

**Compo 900**

Pure architectural light fittings for all applications  
Compo series is a very classic cylindrical design in various sizes and mounting options that integrates elegantly into any architecture.

Uniformly illuminated product thanks to its 2 diffusers design. Opal diffuser provides homogeneous general lighting and Micro-prismatic diffuser is ideal for office lighting.

Available in direct only or direct – indirect light distribution options which perfect for office use, education, healthcare, retail, hospitality, and hotel.

npk design, the Netherlands



**QUICKINFO**

**GENERAL**

Material	Aluminium, Opal cover
Finish	Brushed Silver
IP	IP20
Lifetime	L80/50,000h
Warranty	5 years

**LED**

LED Chip	Seoul
Lumen	9000lm/7000lm/55000lm
Efficacy	100lm/W
CRI	>90
CCT	3000K/4000K Switch as standard, 6500K on request
SDCM	>3
UGR	<19 (X=4H, Y=8H)

**ELECTRICAL**

Voltage	220-240V
Power	90/70/55W Switch
Driver(Build-in)	Phase Cut / DALI
Light distribution	Direct - Indirect

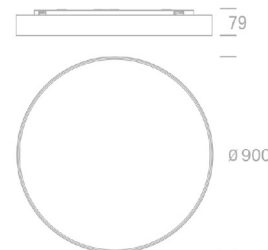
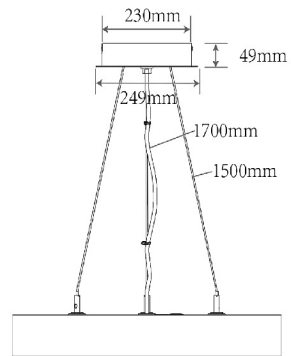

**PURATI PTY LTD**

Unit 10, 80 O'Riordan St, Alexandria NSW 2015  
Tel: +61 2 8065 8181  
sales@purati.com

DESCRIPTION

Compo 900

Pure architectural light fittings for all applications  
Compo series is a very classic cylindrical design in various sizes and mounting options that integrates elegantly into any architecture.

Uniformly illuminated product thanks to its 2 diffusers design. Opal diffuser provides homogeneous general lighting and Micro-prismatic diffuser is ideal for office lighting.

Available in direct only or direct – indirect light distribution options which perfect for office use, education, healthcare, retail, hospitality, and hotel.

npk design, the Netherlands



QUICKINFO

GENERAL

Material	Aluminium, Opal cover
Finish	Brushed Gold
IP	IP20
Lifetime	L80/50,000h
Warranty	5 years

LED

LED Chip	Seoul
Lumen	9000lm/7000lm/55000lm
Efficacy	100lm/W
CRI	>90
CCT	3000K/4000K Switch as standard, 6500K on request
SDCM	>3
UGR	<19 (X=4H, Y=8H)

ELECTRICAL

Voltage	220-240V
Power	90/70/55W Switch
Driver(Build-in)	Phase Cut / DALI
Light distribution	Direct - Indirect

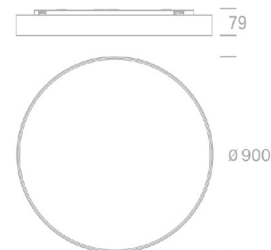
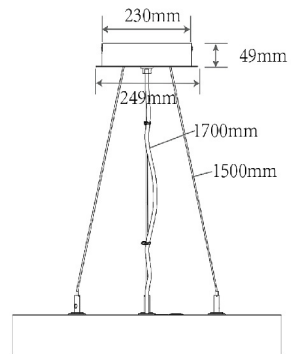

PURATI PTY LTD

Unit 10, 80 O'Riordan St, Alexandria NSW 2015  
Tel: +61 2 8065 8181  
sales@purati.com



**DESCRIPTION**

**Compo 900**

Pure architectural light fittings for all applications  
Compo series is a very classic cylindrical design in various sizes and mounting options that integrates elegantly into any architecture.

Uniformly illuminated product thanks to its 2 diffusers design. Opal diffuser provides homogeneous general lighting and Micro-prismatic diffuser is ideal for office lighting.

Available in direct only or direct – indirect light distribution options which perfect for office use, education, healthcare, retail, hospitality, and hotel.

npk design, the Netherlands



**QUICKINFO**

**GENERAL**

Material	Aluminium, Micro-prismatic cover
Finish	Black
IP	IP20
Lifetime	L80/50,000h
Warranty	5 years

**LED**

LED Chip	Seoul
Lumen	9000lm/7000lm/55000lm
Efficacy	100lm/W
CRI	>90
CCT	3000K/4000K Switch as standard, 6500K on request
SDCM	>3
UGR	<19 (X=4H, Y=8H)

**ELECTRICAL**

Voltage	220-240V
Power	90/70/55W Switch
Driver(Build-in)	Phase Cut / DALI
Light distribution	Direct - Indirect

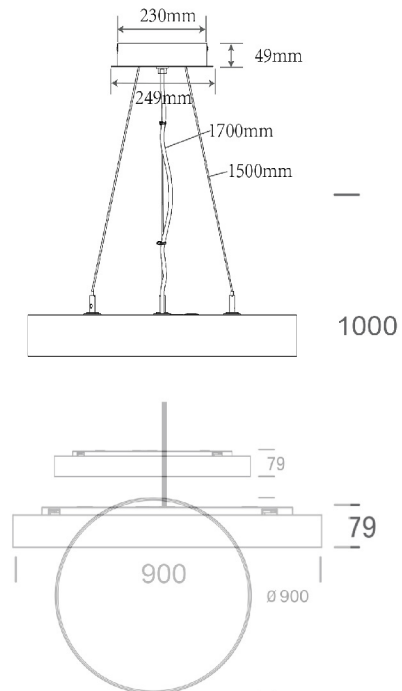

**PURATI PTY LTD**

Unit 10, 80 O'Riordan St, Alexandria NSW 2015  
Tel: +61 2 8065 8181  
sales@purati.com

**DESCRIPTION**

**Compo 900**

Pure architectural light fittings for all applications  
Compo series is a very classic cylindrical design in various sizes and mounting options that integrates elegantly into any architecture.

Uniformly illuminated product thanks to its 2 diffusers design. Opal diffuser provides homogeneous general lighting and Micro-prismatic diffuser is ideal for office lighting.

Available in direct only or direct – indirect light distribution options which perfect for office use, education, healthcare, retail, hospitality, and hotel.

npk design, the Netherlands



**QUICKINFO**

**GENERAL**

Material	Aluminium, Micro-prismatic cover
Finish	White
IP	IP20
Lifetime	L80/50,000h
Warranty	5 years

**LED**

LED Chip	Seoul
Lumen	9000lm/7000lm/55000lm
Efficacy	100lm/W
CRI	>90
CCT	3000K/4000K Switch as standard, 6500K on request
SDCM	>3
UGR	<19 (X=4H, Y=8H)

**ELECTRICAL**

Voltage	220-240V
Power	90/70/55W Switch
Driver(Build-in)	Phase Cut / DALI
Light distribution	Direct - Indirect

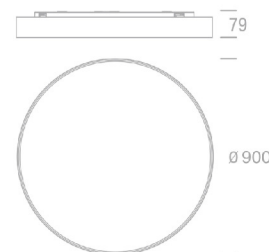
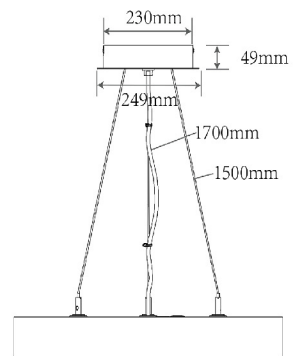

**PURATI PTY LTD**

Unit 10, 80 O'Riordan St, Alexandria NSW 2015  
Tel: +61 2 8065 8181  
sales@purati.com

**DESCRIPTION**

**Compo 900**

Pure architectural light fittings for all applications  
Compo series is a very classic cylindrical design in various sizes and mounting options that integrates elegantly into any architecture.  
Uniformly illuminated product thanks to its 2 diffusers design. Opal diffuser provides homogeneous general lighting and Micro-prismatic diffuser is ideal for office lighting.  
Available in direct only or direct – indirect light distribution options which perfect for office use, education, healthcare, retail, hospitality, and hotel.  
npk design, the Netherlands



**QUICKINFO**

**GENERAL**

Material	Aluminium, Micro-prismatic cover
Finish	Brushed Silver
IP	IP20
Lifetime	L80/50,000h
Warranty	5 years

**LED**

LED Chip	Seoul
Lumen	9000lm/7000lm/55000lm
Efficacy	100lm/W
CRI	>90
CCT	3000K/4000K Switch as standard, 6500K on request
SDCM	>3
UGR	<19 (X=4H, Y=8H)

**ELECTRICAL**

Voltage	220-240V
Power	90/70/55W Switch
Driver(Build-in)	Phase Cut / DALI
Light distribution	Direct - Indirect

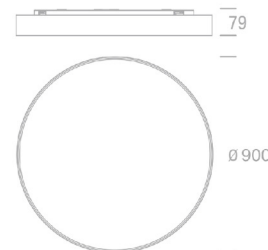
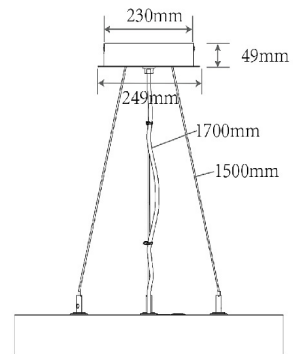

**DESCRIPTION**

**Compo 900**

Pure architectural light fittings for all applications  
Compo series is a very classic cylindrical design in various sizes and mounting options that integrates elegantly into any architecture.

Uniformly illuminated product thanks to its 2 diffusers design. Opal diffuser provides homogeneous general lighting and Micro-prismatic diffuser is ideal for office lighting.

Available in direct only or direct – indirect light distribution options which perfect for office use, education, healthcare, retail, hospitality, and hotel.

npk design, the Netherlands



**QUICKINFO**

**GENERAL**

Material	Aluminium, Micro-prismatic cover
Finish	Brushed Gold
IP	IP20
Lifetime	L80/50,000h
Warranty	5 years

**LED**

LED Chip	Seoul
Lumen	9000lm/7000lm/55000lm
Efficacy	100lm/W
CRI	>90
CCT	3000K/4000K Switch as standard, 6500K on request
SDCM	>3
UGR	<19 (X=4H, Y=8H)

**ELECTRICAL**

Voltage	220-240V
Power	90/70/55W Switch
Driver(Build-in)	Phase Cut / DALI
Light distribution	Direct - Indirect

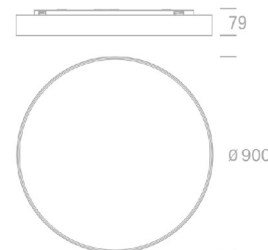
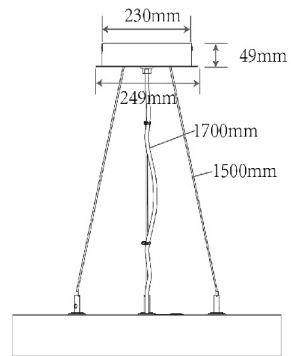

**PURATI PTY LTD**

Unit 10, 80 O'Riordan St, Alexandria NSW 2015  
Tel: +61 2 8065 8181  
sales@purati.com