

DESCRIPTION

FLOAT

Timeless design. 360° perfect illumination.

The Float series by European design is an outstanding interior luminaire offering floating elegance, timeless aesthetic, and extremely homogenous omnidirectional illumination.

With a minimalist design and versatile application such as ceiling and wall mounting as well as perfectly suspended with a wire or rod, combine with the handmade frosted acrylic diffuser with perfect light uniformity, high quality Seoul LEDs (up to 132lm/W) and multiple functions, making it ideal for office, education, retail, hospitality, and public spaces.



QUICKINFO

GENERAL

Finish	White
Material	Metal + Acrylic
IP	20
Lifespan	L80/50,000h
Warranty	5 years

LED

Optic	Opal Diffuser
Lumen	3168lm / 2376lm / 1320lm
Efficacy	132lm/w
CRI	>90
CCT	3000k / 4000k
SDCM	>3
UGR	>25

ELECTRICAL

Voltage	220-240V
Power	24/18/10w Switch
Driver(Build-in)	Phase Cut / DALI

Energy efficiency class class <C>

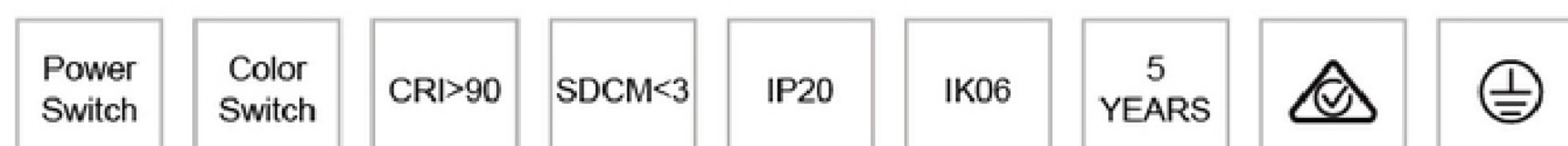
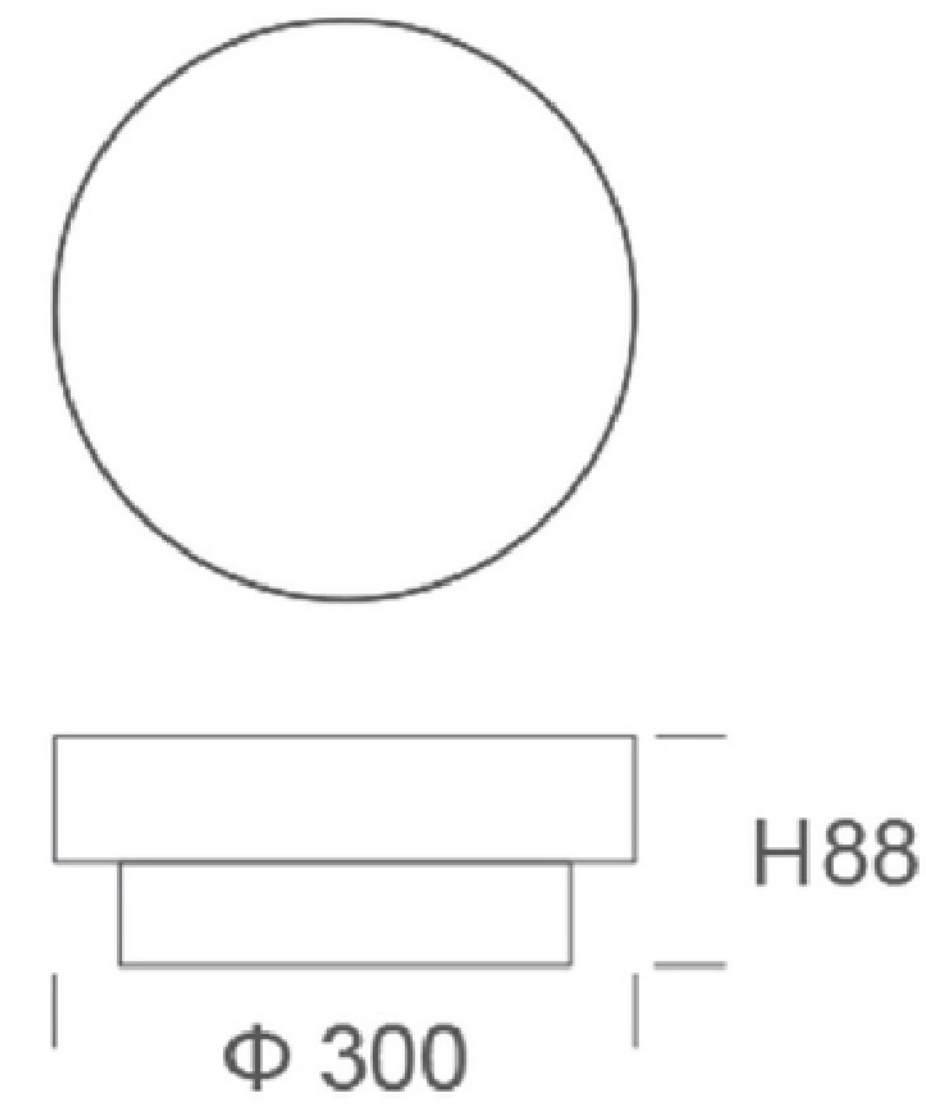

DESCRIPTION

FLOAT

Timeless design. 360° perfect illumination.

The Float series by European design is an outstanding interior luminaire offering floating elegance, timeless aesthetic, and extremely homogenous omnidirectional illumination.

With a minimalist design and versatile application such as ceiling and wall mounting as well as perfectly suspended with a wire or rod, combine with the handmade frosted acrylic diffuser with perfect light uniformity, high quality Seoul LEDS (up to 132lm/W) and multiple functions, making it ideal for office, education, retail, hospitality, and public spaces.



QUICKINFO

GENERAL

Finish	Black
Material	Metal + Acrylic
IP	20
Lifespan	L80/50,000h
Warranty	5 years

LED

Optic	Opal Diffuser
Lumen	3168lm / 2376lm / 1320lm
Efficacy	132lm/w
CRI	>90
CCT	3000k / 4000k
SDCM	>3
UGR	>25

ELECTRICAL

Voltage	220-240V
Power	24/18/10w Switch
Driver(Build-in)	Phase Cut / DALI

Energy efficiency class class <C>

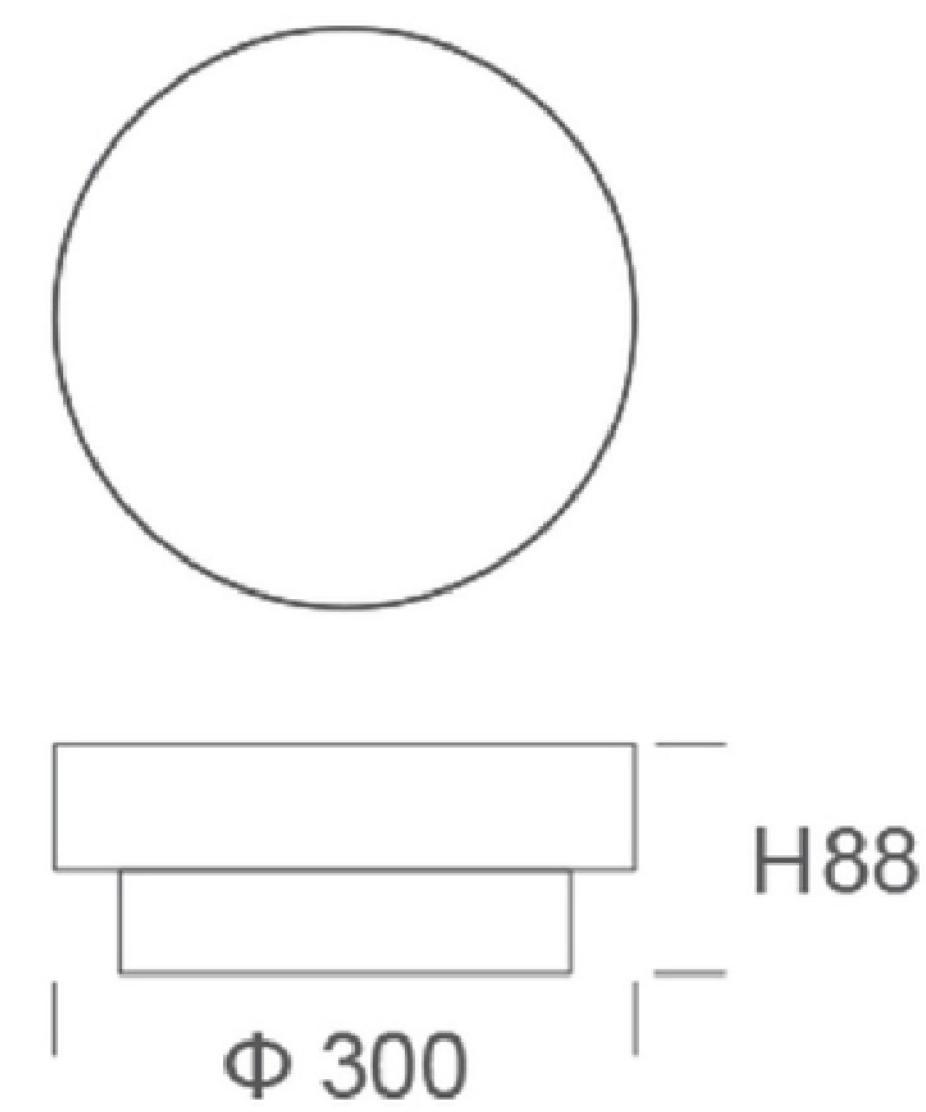

PURATI PTY LTD

Unit 10, 80 O'Riordan St, Alexandria NSW 2015
Tel: +61 2 8065 8181
sales@purati.com

DESCRIPTION

FLOAT

Timeless design. 360° perfect illumination.

The Float series by European design is an outstanding interior luminaire offering floating elegance, timeless aesthetic, and extremely homogenous omnidirectional illumination.

With a minimalist design and versatile application such as ceiling and wall mounting as well as perfectly suspended with a wire or rod, combine with the handmade frosted acrylic diffuser with perfect light uniformity, high quality Seoul LEDS (up to 132lm/W) and multiple functions, making it ideal for office, education, retail, hospitality, and public spaces.



QUICKINFO

GENERAL

Finish	Black
Materiall	Metal + Acrylic
IP	20
Lifespan	L80/50,000h
Warranty	5 years

LED

Optic	Opal Diffuser
Lumen	3168lm / 2376lm / 1320lm
Efficary	132lm/w
CRI	>90
CCT	3000k / 4000k
SDCM	>3
UGR	>25

ELECTRICAL

Voltage	220-240V
Power	24/18/10w Switch
Driver(Build-in)	Phase Cut / DALI

Energy efficiency class class <C>

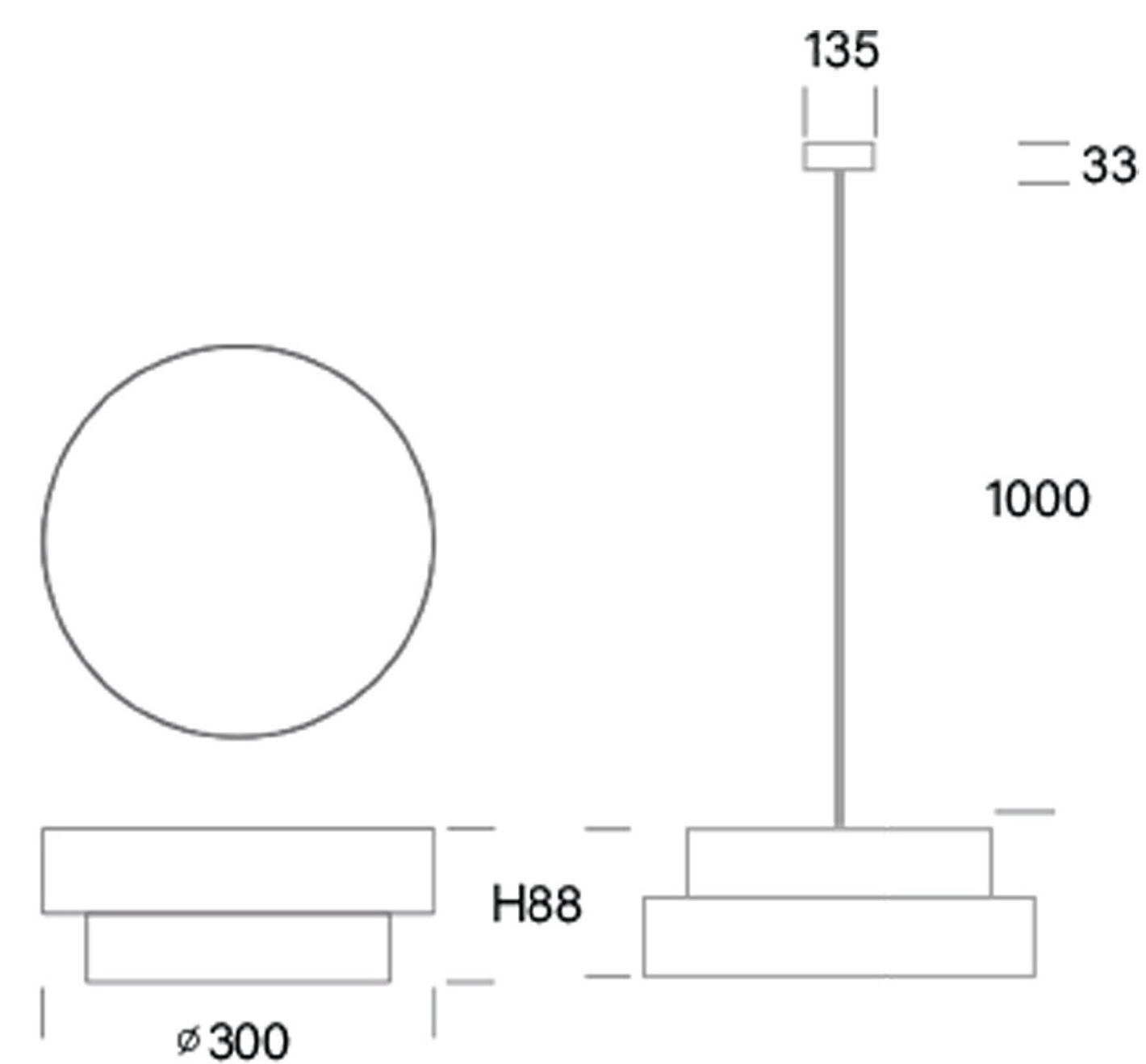

DESCRIPTION

FLOAT

Timeless design. 360° perfect illumination.

The Float series by European design is an outstanding interior luminaire offering floating elegance, timeless aesthetic, and extremely homogenous omnidirectional illumination.

With a minimalist design and versatile application such as ceiling and wall mounting as well as perfectly suspended with a wire or rod, combine with the handmade frosted acrylic diffuser with perfect light uniformity, high quality Seoul LEDS (up to 132lm/W) and multiple functions, making it ideal for office, education, retail, hospitality, and public spaces.



QUICKINFO

GENERAL

Finish	White
Material	Metal + Acrylic
IP	20
Lifespan	L80/50,000h
Warranty	5 years

LED

Optic	Opal Diffuser
Lumen	3168lm / 2376lm / 1320lm
Efficacy	132lm/w
CRI	>90
CCT	3000k / 4000k
SDCM	>3
UGR	>25

ELECTRICAL

Voltage	220-240V
Power	24/18/10w Switch
Driver(Build-in)	Phase Cut / DALI

Energy efficiency class **class <C>**

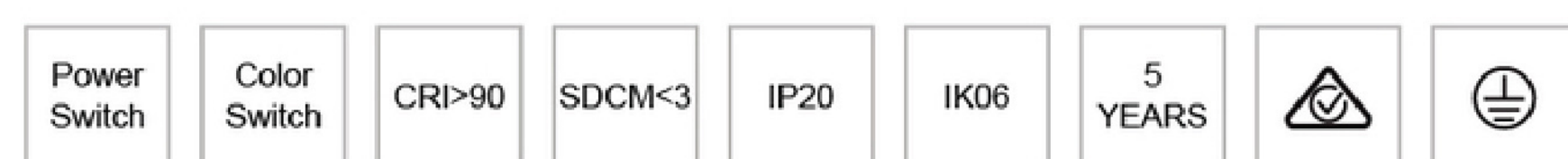
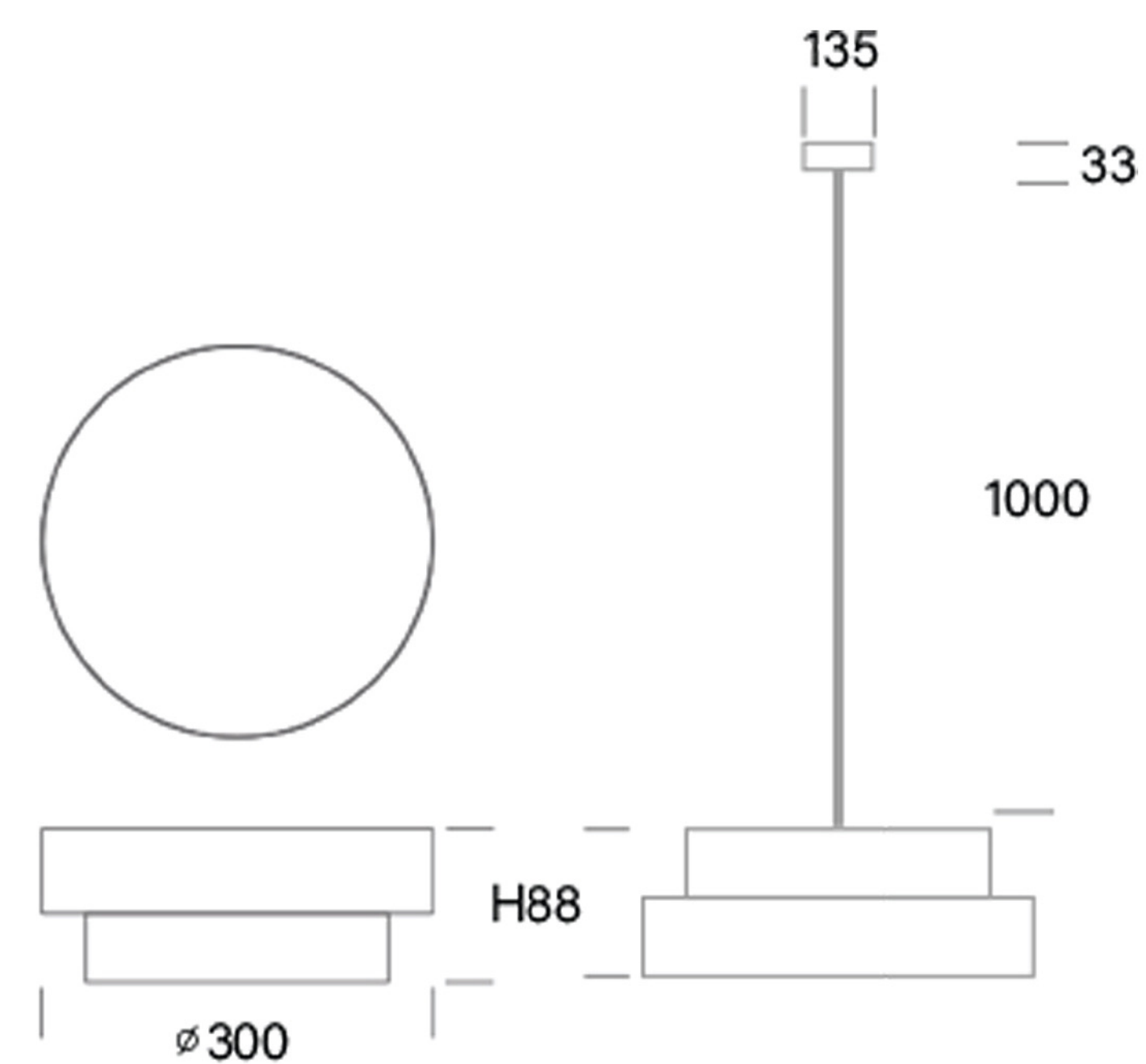

PURATI PTY LTD

Unit 10, 80 O'Riordan St, Alexandria NSW 2015
Tel: +61 2 8065 8181
sales@purati.com

DESCRIPTION

FLOAT

Timeless design. 360° perfect illumination.

The Float series by European design is an outstanding interior luminaire offering floating elegance, timeless aesthetic, and extremely homogenous omnidirectional illumination.

With a minimalist design and versatile application such as ceiling and wall mounting as well as perfectly suspended with a wire or rod, combine with the handmade frosted acrylic diffuser with perfect light uniformity, high quality Seoul LEDS (up to 132lm/W) and multiple functions, making it ideal for office, education, retail, hospitality, and public spaces.



QUICKINFO

GENERAL

Finish	Black
Material	Metal + Acrylic
IP	20
Lifespan	L80/50,000h
Warranty	5 years

LED

Optic	Opal Diffuser
Lumen	3168lm / 2376lm / 1320lm
Efficacy	132lm/w
CRI	>90
CCT	3000k / 4000k
SDCM	>3
UGR	>25

ELECTRICAL

Voltage	220-240V
Power	24/18/10w Switch
Driver(Build-in)	Phase Cut / DALI

Energy efficiency class **class <C>**

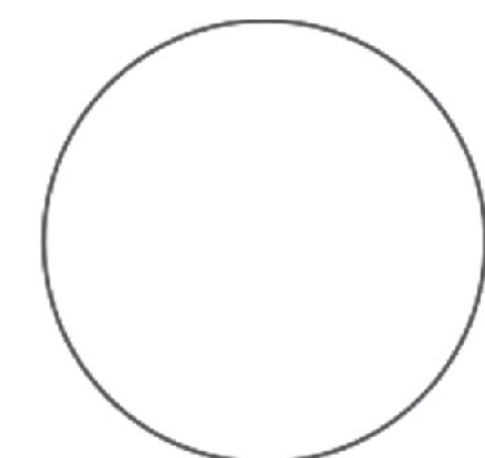
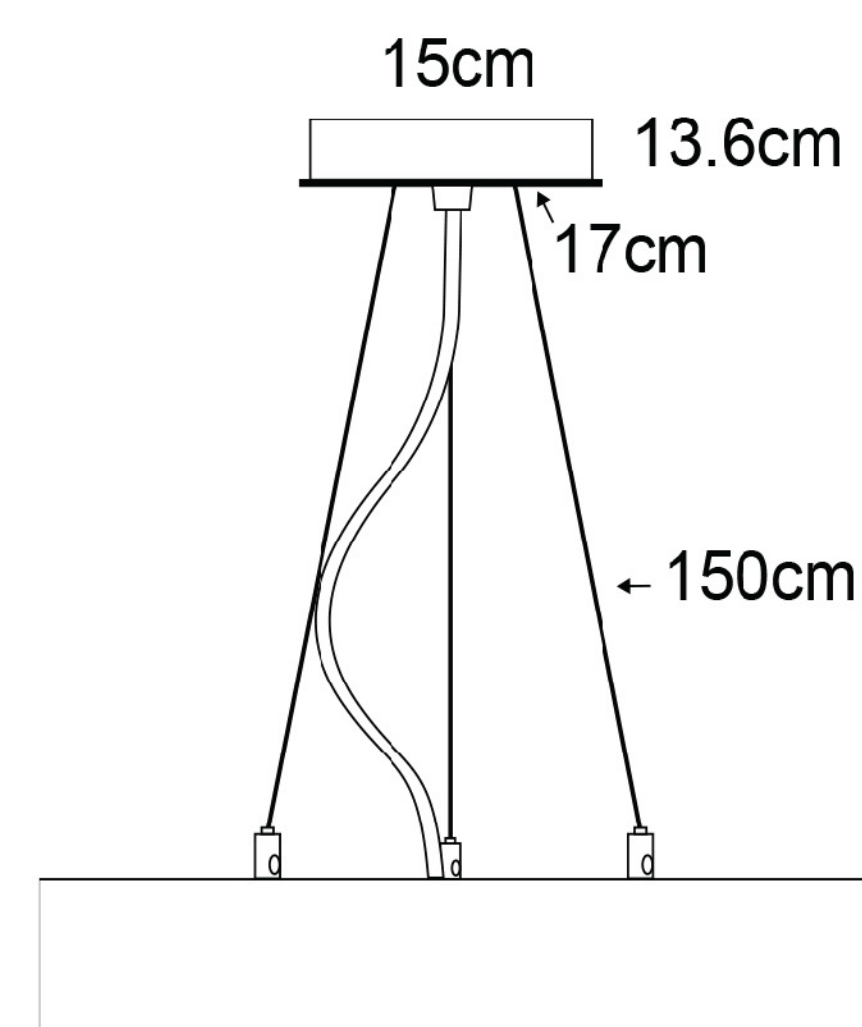

DESCRIPTION

FLOAT

Timeless design. 360° perfect illumination.

The Float series by European design is an outstanding interior luminaire offering floating elegance, timeless aesthetic, and extremely homogenous omnidirectional illumination.

With a minimalist design and versatile application such as ceiling and wall mounting as well as perfectly suspended with a wire or rod, combine with the handmade frosted acrylic diffuser with perfect light uniformity, high quality Seoul LEDS (up to 132lm/W) and multiple functions, making it ideal for office, education, retail, hospitality, and public spaces.



QUICKINFO

GENERAL

Finish	White
Material	Metal + Acrylic
IP	20
Lifespan	L80/50,000h
Warranty	5 years

LED

Optic	Opal Diffuser
Lumen	3168lm / 2376lm / 1320lm
Efficacy	132lm/w
CRI	>90
CCT	3000k / 4000k
SDCM	>3
UGR	>25

ELECTRICAL

Voltage	220-240V
Power	24/18/10w Switch
Driver(Build-in)	Phase Cut / DALI

Energy efficiency class class <C>

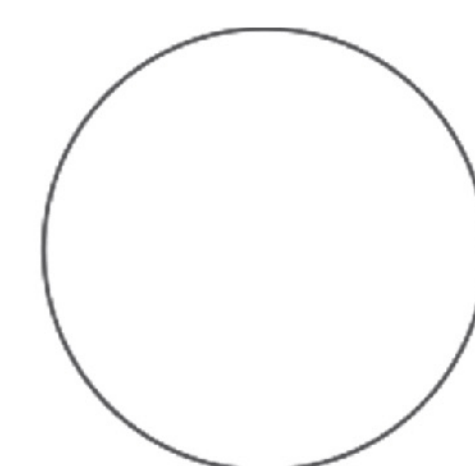
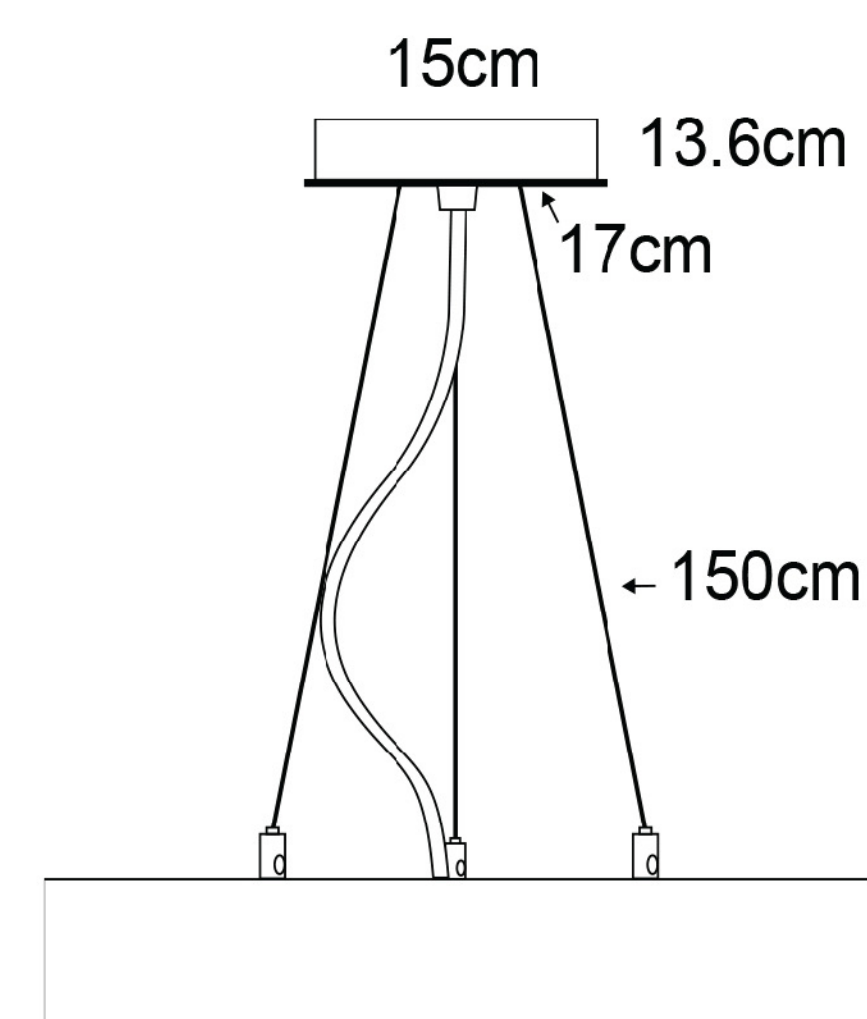

CONE DIAGRAM

m	Φ cm	Lux AVG	Lux MAX
1	373.69	82.67	365.31
2	747.39	20.67	91.321
3	1121.08	9.186	40.591
4	1494.78	5.167	22.831
5	1868.47	3.307	14.611

Angle : 123.69 DEG

Float 300 10w 3000k

POLAR DIAGRAM

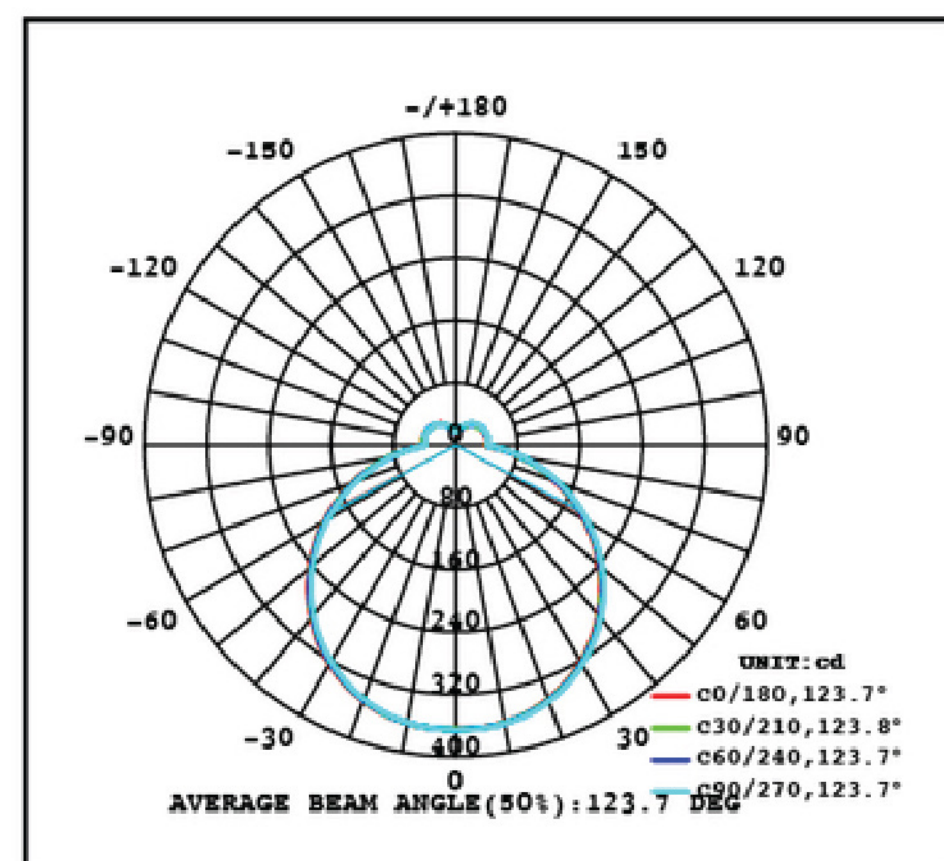

CONE DIAGRAM

m	Φ cm	Lux AVG	Lux MAX
1	373.83	85.73	378.81
2	747.66	21.43	94.691
3	1121.49	9.526	42.801
4	1495.32	5.358	23.671
5	1869.16	3.429	15.151

Angle : 123.71 DEG

Float 300 10w 4000k

POLAR DIAGRAM

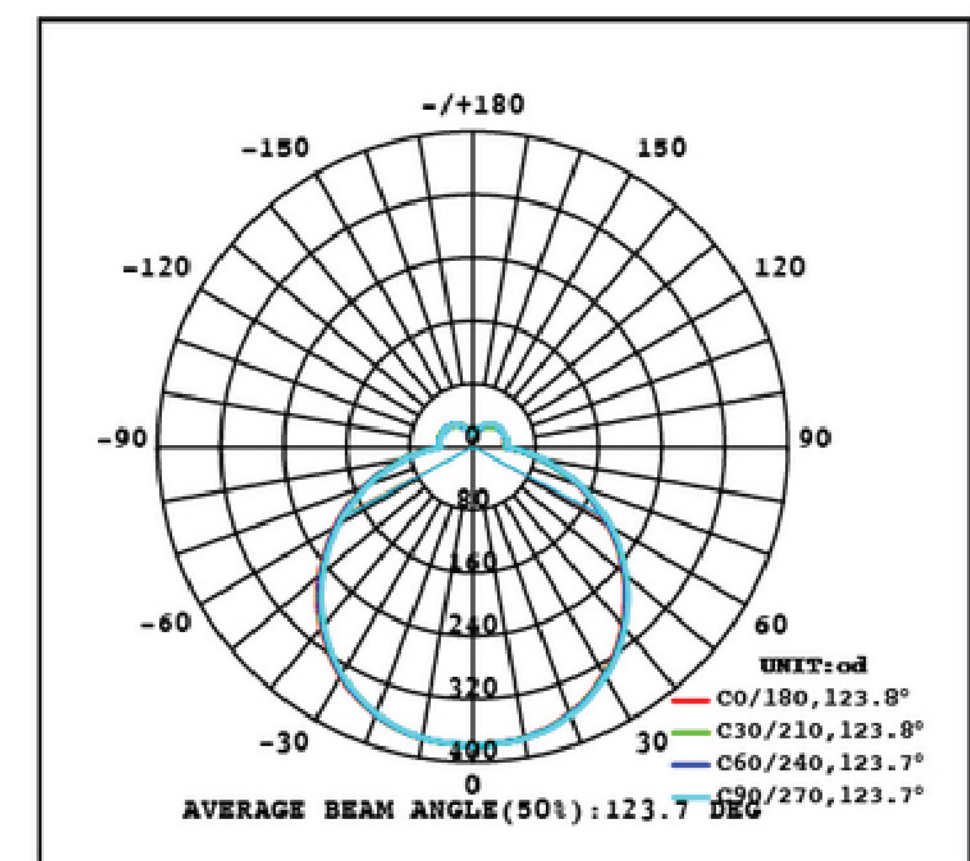

CONE DIAGRAM

m	Φ cm	Lux AVG	Lux MAX
1	373.36	139.5	616.71
2	746.72	34.87	154.21
3	1120.08	15.50	68.521
4	1493.44	8.718	38.541
5	1866.80	5.579	24.671

Angle : 123.65 DEG

Float 300 18w 3000k

POLAR DIAGRAM

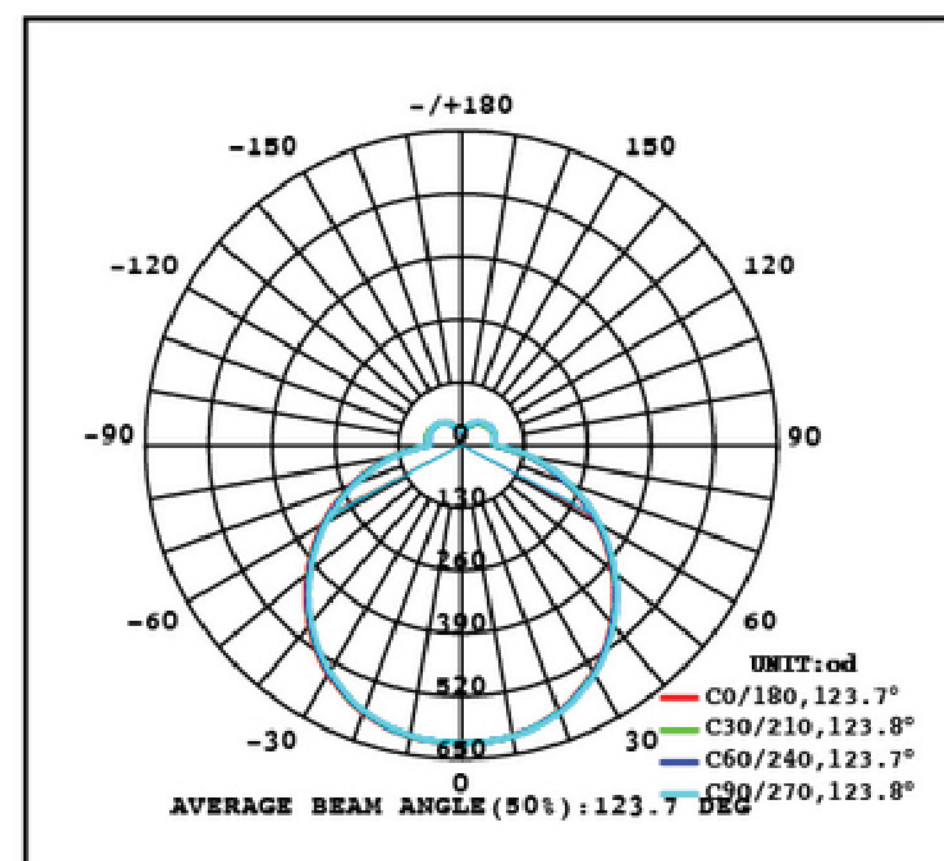

CONE DIAGRAM

m	Φ cm	Lux AVG	Lux MAX
1	373.99	144.5	638.31
2	747.98	36.13	159.61
3	1121.96	16.06	70.921
4	1495.95	9.032	39.901
5	1869.94	5.781	25.531

Angle : 123.73 DEG

Float 300 18w 4000k

POLAR DIAGRAM

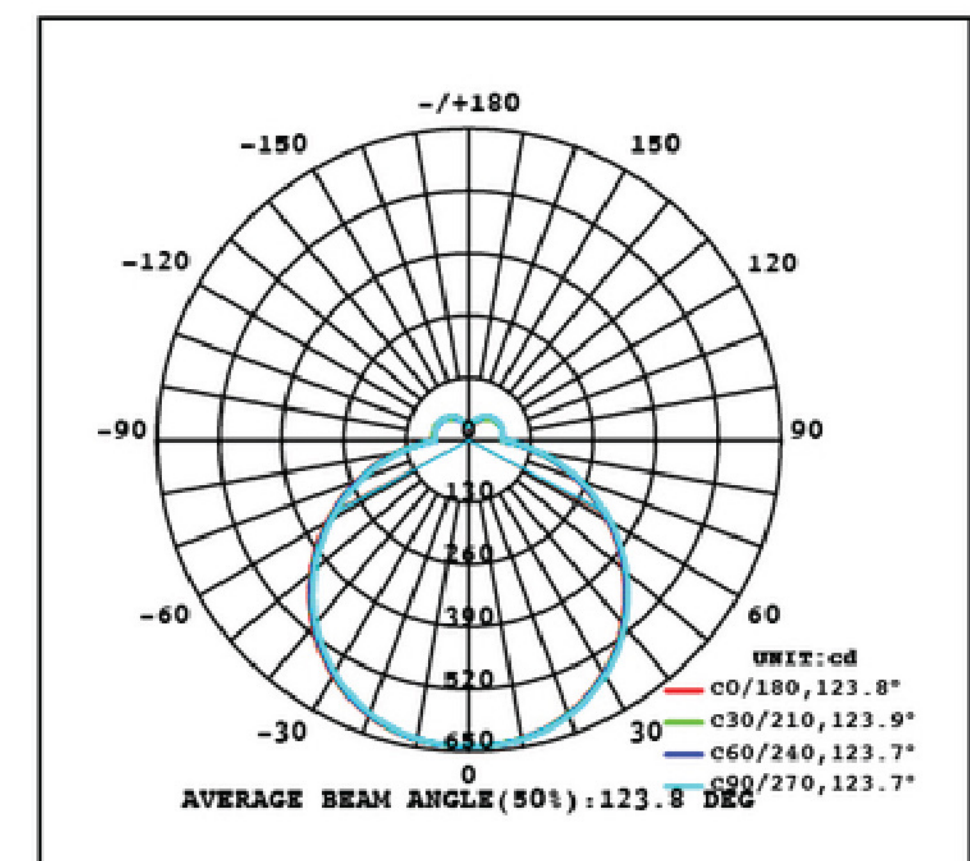

CONE DIAGRAM

m	Φ cm	Lux AVG	Lux MAX
1	373.28	181.7	803.51
2	746.57	45.43	200.91
3	1119.85	20.19	89.271
4	1493.13	11.36	50.221
5	1866.41	7.268	32.141

Angle : 123.64 DEG

Float 300 24w 3000k

POLAR DIAGRAM

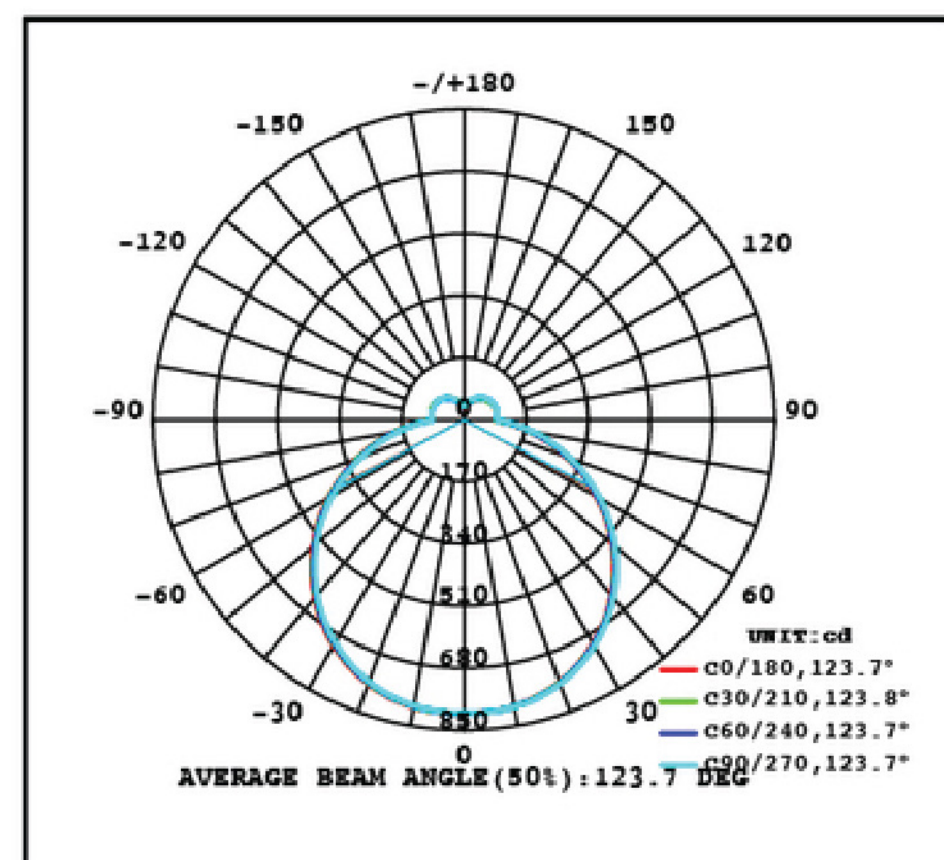

CONE DIAGRAM

m	Φ cm	Lux AVG	Lux MAX
1	372.97	189.6	839.01
2	745.94	47.40	209.71
3	1118.91	21.07	93.221
4	1491.88	11.85	52.431
5	1864.85	7.584	33.561

Angle : 123.60 DEG

Float 300 24w 4000k

POLAR DIAGRAM

