

PURATI

## POINT R TRACK LIGHT L INSTALLATION GUIDELINES

### PREPARATION:

- The mains isolator on the consumer unit/fuse board must be in "OFF" position before commencing any electrical work.
- The luminaires should be mounted into the correct 3-phase track.
- With all painted / plated products some shade and finishing variation may occur, please make sure luminaires are checked before installation.
- The manufacturer reserves the right to improve the product specification without prior notice.



IP20

Installation must be done by a qualified electrician.

DRIVER

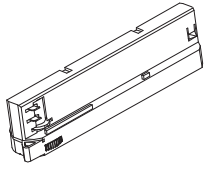

FRONT SIDE



PROFILE

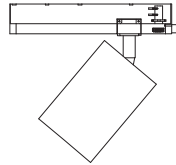

CONNECTION PREVIEW

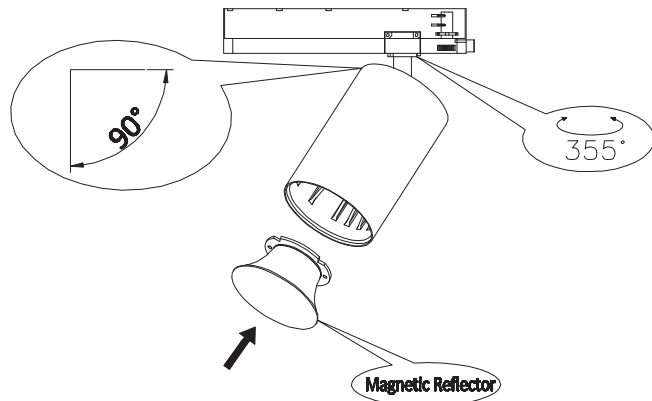

Structure diagram of Track and adaptor;

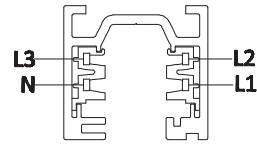

Earthing

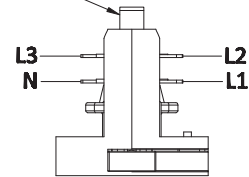

2

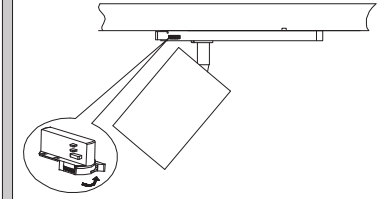

2) Put the adaptor into the track and hook it. Choose L1/L2/L3 on the knob according to your circuit;

1

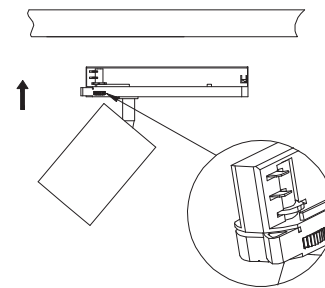

1) The arrow must be aligned with the "0"/"OFF" point on the knob to keep 4 pins inside;

3

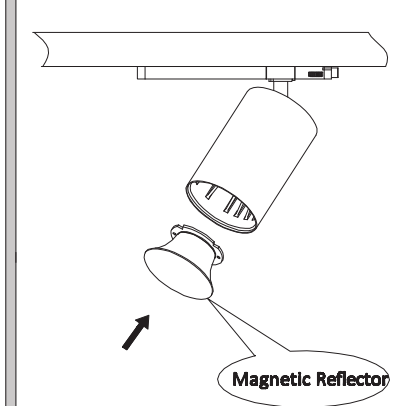

3) Install the magnetic reflector if not mounted from our factory;