

PURATI.



COMPO

Design

---

n p k | design

PURATI,

Production

---

Close collaboration between  
Purati and npk design  
the mission is to create the  
great products & bring new  
lighting solutions for architecture.





## npk design b.v.

Our designs are made by npk design b.v. is an award-winning design agency which has developed a wide range of successfully products for us more than 10 years.

From Slice series to Fusi series, has been gaining prestigious international design awards such as IF Design Award, Red Dot Award, German Design Award.







## Purati

Performance, Uniqueness, Responsibility, Aesthetics, Technology, Innovation (PURATI). Those are our core value and foundation.

Our lights save space, save resources, and offer greater quality.

We offer architectural lighting of premium quality and performance and with unique design.



PURATI

6

PURATI

PURATI

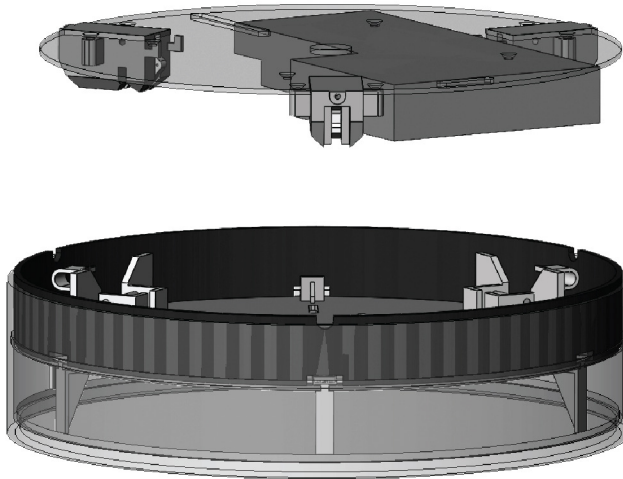

# COMPO

**Designed by npk design b.v.**

Minimalist design with perfect light uniformity for an open feeling of space. This series is a very classic cylindrical design in various sizes and mounting options that integrates elegantly into any architecture.





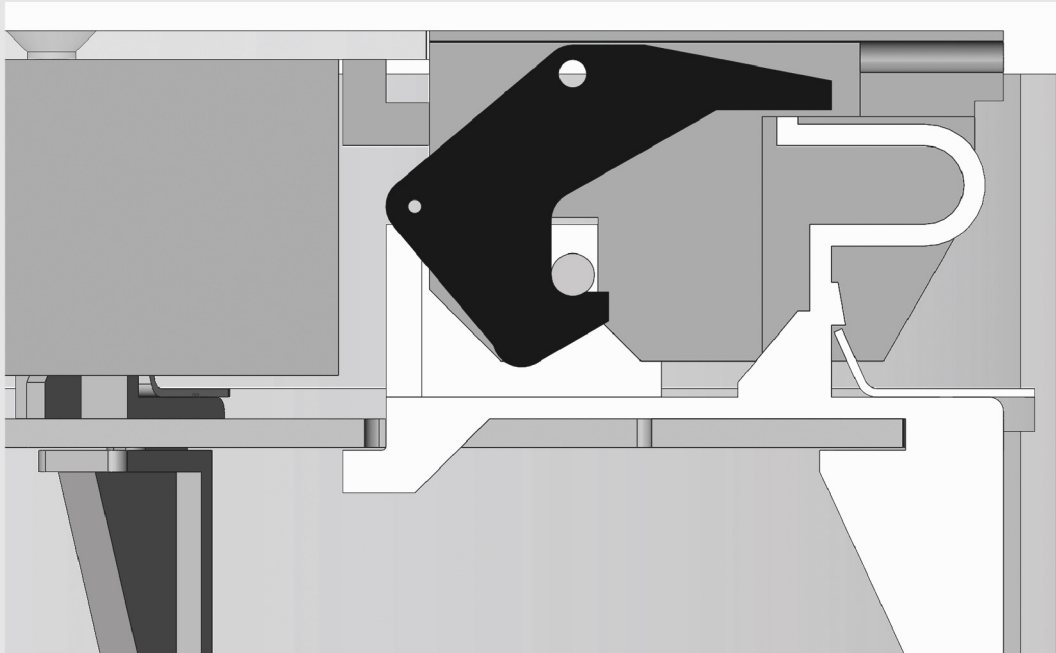

**The initial design**



## **Innovative design - all in one base**

Direct/indirect light distribution,  
ambient light distribution.  
(Indirect light can be switched  
on/off button on the luminaire base)

# Explore the essence of Compo series

## **Ambient light**

Perfect light uniformity with zero dotting,  
high efficiency and perfect glare control  
thanks to prismatic diffuser.

## **European design**

Slim Trim Design, impressed with simplicity  
and elegance.

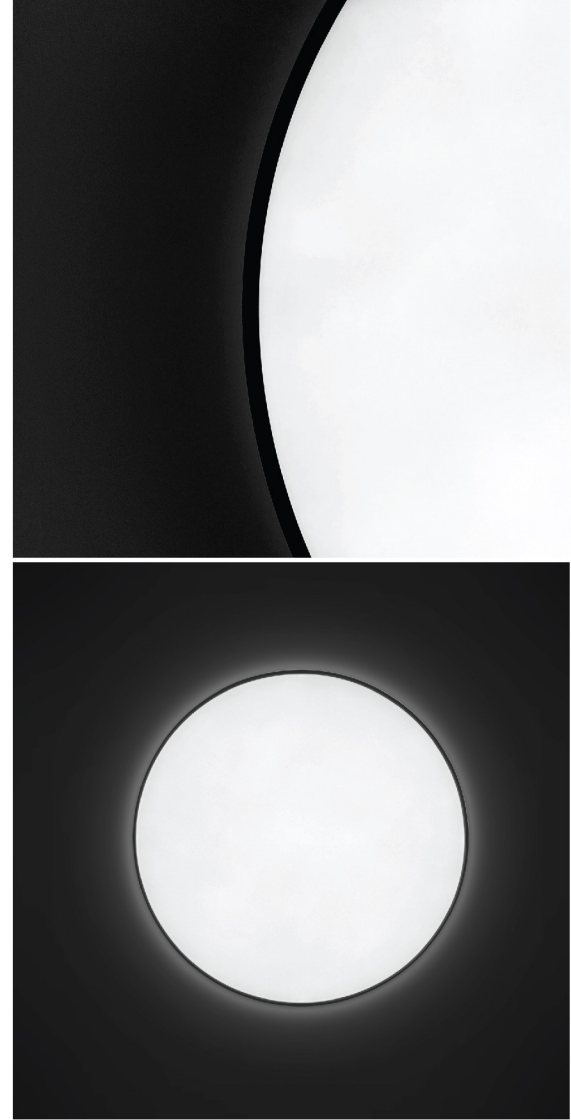



Simply  
everywhere

A very classic cylindrical design in various sizes and mounting options that integrated elegantly into any architecture.

# Tuneable white version

TW only for Compo direct  
version, the CCT change  
between warm white and  
cool white light via  
DALI DT8.





# Areas of application

- Office
- Education
- Retail
- Hospitality
- Public space

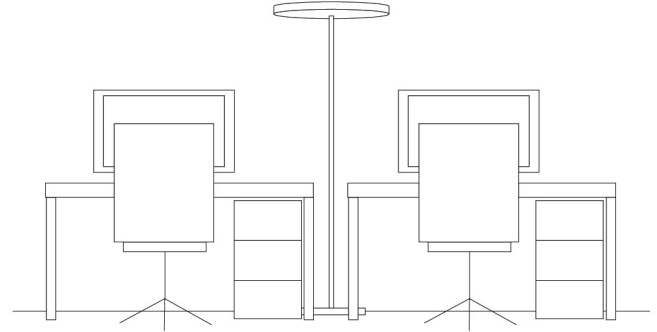

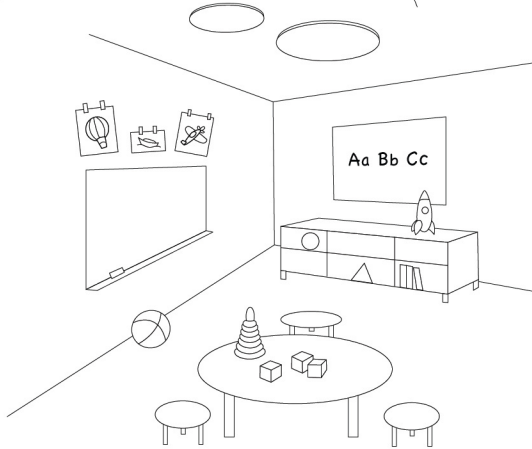
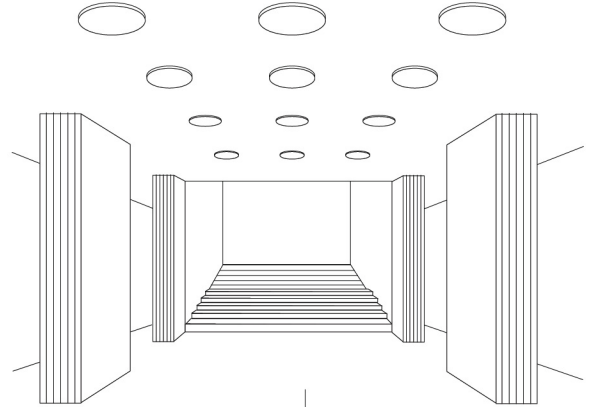
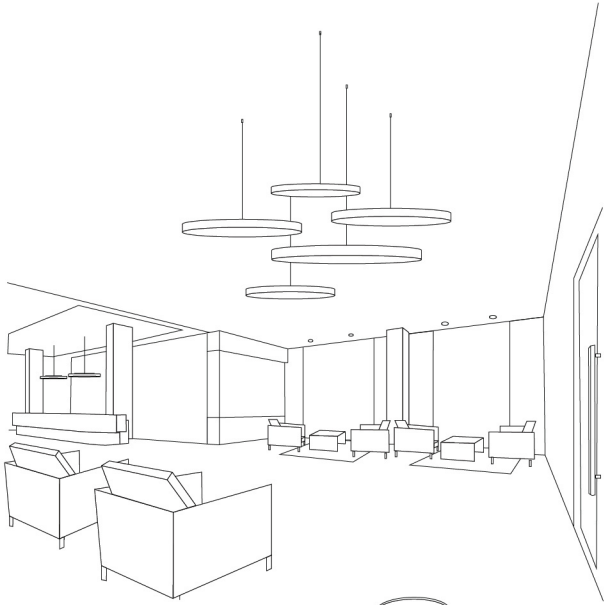

# Technical data

	Size	Power	Lumens (at 3000k)	Beam Angle	Efficacy	Driver
① Compo 320	320mm	24/18/10W	2400/1800lm	120°	100lm/W	Non-DIM (Build-in),
② Compo 450	450mm	30/22W	3100/2300lm	120°	100lm/W	Phase cut (Build-in),
③ Compo 600	600mm	55/38W	5500/4000lm	120°	100lm/W	DALI (Build-in),
④ Compo 900	900mm	90/70/55W	9000/7000/5500lm	120°	100lm/W	Bluetooth (Remote)

## General

Finishes	<input type="checkbox"/> White
	<input type="checkbox"/> Black
	<input type="checkbox"/> Brushed Silver
	<input type="checkbox"/> Brushed Brass
	<input type="checkbox"/> Brushed Gold

Material Aluminium

IP Rating IP20

IK Rating IK08

Lifespan L80/50,000h

Warranty 5 Years

## LED

CCT 3000K/4000K Switch

CRI >90

SDCM <3

UGR <19 or <23 (X=4H, Y=8H)

## Electrical

Diffuser Opal  
Micro-prismatic optional

Light distribution Direct only  
Direct and indirect lighting optional

Mounting Surface mounted  
Rod Suspension (1m)  
Wire Suspension (2m)  
Wall mounted

Function PIR sensor  
Emergency (2W 90mins/180mins Lithium cell)  
Sensor + Emergency

1

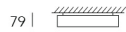

Ø 320

3

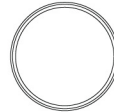
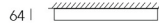

Ø 600

2

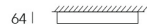
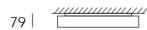

Ø 450

4

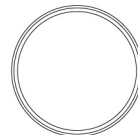
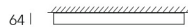
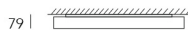

Ø 900

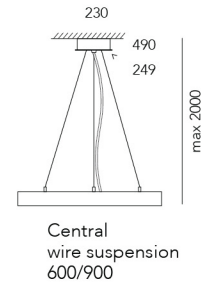
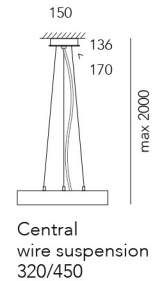
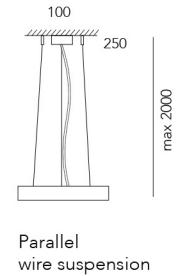
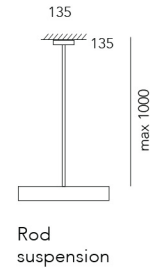

**Head Office**

Unit 10, 80 O'Riordan Street,  
Alexandria NSW 2015

**Phone**

+61 2 8065 8181

**Email**

[sales@purati.com](mailto:sales@purati.com)



[www.purati.com](http://www.purati.com)