

LED Surface / Spike Light Instruction Leaflet

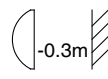

IP67 RoHS



EN

Read this instruction carefully before commencing installation and keep it for future reference.

Always switch off the mains before installation or maintenance.

Keep the product far from heat sources and in a well ventilated area.

The installation or maintenance should be carried out by a qualified electrician.



The light source contained in this luminaire shall only be replaced by the manufacturer or his service agent or a similar qualified person.

Tree Version

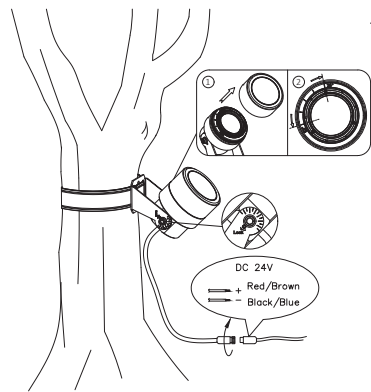
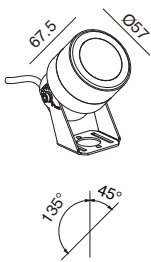

Spike Version

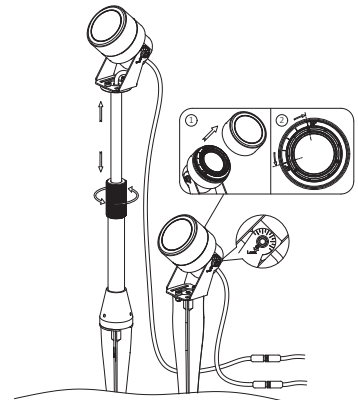
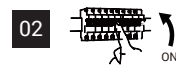
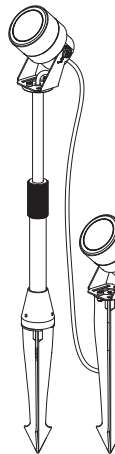
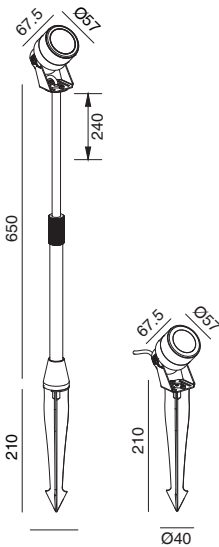

Surface Version

